

Modeling of Orthogonal Frequency Division Multiplexing (OFDM) for Transmission in Broadband Wireless Communications

¹ John Samuel, ² Akinola Emmanuel, ¹ Ibikunle Frank, ¹ Ndujiuba Charles, ² Akinade Bayonle,

¹ Covenant University, Ota, Nigeria, ² University of Lagos, Akoka, Nigeria

¹ samuel.john@covenantuniversity.edu.ng, ² akinola.emmanuel@gmail.com, ¹ faibikunle2@yahoo.co.uk,

¹ charles.ndujiuba@covenantuniversity.edu.ng, ² bayonleakinade@yahoo.com,

ABSTRACT

Orthogonal Frequency Division Multiplexing (OFDM) is a multi carrier modulation technique that provides high bandwidth efficiency because the carriers are orthogonal to each other and multiple carriers share the data among themselves. The main advantage of this transmission technique is its robustness to channel fading in wireless communication environment. This paper investigates the effectiveness of OFDM and assesses its suitability as a modulation technique in wireless communications. Several of the main factors affecting the performance of a typical OFDM system are considered and they include multipath delay spread, channel noise, distortion (clipping), and timing requirements. The core processing block and performance analysis of the system is modeled using Matlab.

Keywords: *Fast Fourier Transform, OFDM, CDMA, FDMA, TDMA, BER*

1. INTRODUCTION

Orthogonal Frequency Division Multiplexing (OFDM) is a multicarrier transmission technique, which divides the available spectrum into many carriers, each one being modulated by a low rate data stream. OFDM is similar to FDMA in that the multiple user access is achieved by subdividing the available bandwidth into multiple channels, which are then allocated to users. However, OFDM uses the spectrum much more efficiently by spacing the channels much closer together. This is achieved by making all the carriers orthogonal to one another, preventing interference between the closely spaced carriers. Coded Orthogonal Frequency Division Multiplexing (COFDM) is the same as OFDM except that forward error correction is applied to the signal before transmission. This is to overcome errors in the transmission due to lost carriers from frequency selective fading, channel noise and other propagation effects. For this discussion the terms OFDM and COFDM are used interchangeably, as the main focus of this work is on OFDM, but it is assumed that any practical system will use forward error correction, thus would be COFDM.

OFDM can be viewed as a collection of transmission techniques. When this technique is applied in wireless environment, it is referred to as OFDM. In the wired environment, such as asymmetric digital subscriber lines (ADSL), it is referred to as discrete multi tone (DMT). In OFDM, each carrier is orthogonal to all other carriers. However, this condition is not always maintained in DMT [1]. OFDM is an optimal version of multi carrier transmission schemes. OFDM started in the mid 60's, Chang proposed a method to synthesize band limited signals for multi channel transmission [2]. The idea is to transmit signals simultaneously through a linear band limited channel without inter channel (ICI) and inter symbol interference (ISI). After that, Saltzberg performed an analysis based on Chang's work and he concluded that the focus to design a multi channel transmission must concentrate on reducing crosstalk between adjacent

channels rather than on perfecting the individual signals [3].

In FDMA each user is typically allocated a single channel, which is used to transmit all the user information. The bandwidth of each channel is typically 10kHz-30kHz for voice communications. However, the minimum required bandwidth for speech is only 3kHz. The allocated bandwidth is made wider than the minimum amount required to prevent channels from interfering with one another. This extra bandwidth is to allow for signals from neighbouring channels to be filtered out, and to allow for any drift in the centre frequency of the transmitter or receiver. In a typical system up to 50% of the total spectrum is wasted due to the extra spacing between channels. This problem becomes worse as the channel bandwidth becomes narrower, and the frequency band increases.

OFDM overcomes most of the problems with both FDMA and TDMA. OFDM splits the available bandwidth into many narrow band channels (typically 100-8000). The carriers for each channel are made orthogonal to one another, allowing them to be spaced very close together, with no overhead as in the FDMA example. Because of this there is no great need for users to be time multiplexed as in TDMA, thus there is no overhead associated with switching between users. The orthogonality of the carriers means that each carrier has an integer number of cycles over a symbol period. Due to this, the spectrum of each carrier has a null at the centre frequency of each of the other carriers in the system. This results in no interference between the carriers, allowing them to be spaced as close as theoretically possible. This overcomes the problem of overhead carrier spacing required in FDMA. Each carrier in an OFDM signal has a very narrow bandwidth (i.e. 1 kHz), thus the resulting symbol rate is low. This results in the signal having a high tolerance to multipath delay spread, as the delay spread must be very long to cause significant inter-symbol interference (e.g. > 100 ms). The paper is organized as follows: section 2 gives the overview

of the OFDM and describes the system model for the OFDM stating the advantages for the OFDM transmission and the drawbacks. Section 3 gives the project methodology describing the methods employed for modeling the OFDM transmission and the reception. Section 4 gives the suitability of the OFDM transmission in a broadband wireless communication and its high tolerance to interference as verified by its performance in relation to four main parameters- Multipath delay, peak power clipping, Gaussian noise tolerance and timing requirement while section 5 gives the application of the OFDM and areas that need further research.

2. OFDM SYSTEM MODEL

OFDM) is of great interest by researchers and research laboratories all over the world. It has already been accepted for the new wireless local area network standards IEEE 802.11a, High Performance LAN type 2 (HIPERLAN/2) and Mobile Multimedia Access Communication (MMAC) Systems. Also, it is expected to be used for wireless broadband multimedia communications. This new standards specify bit rates of up to 54 Mbps. OFDM can be seen as either a modulation technique or a multiplexing technique. One of the main reasons to use OFDM is to increase the robustness against frequency selective fading or narrowband interference. In a single carrier system, a single fade or interferer can cause the entire link to fail, but in a multicarrier system, only a small percentage of the subcarriers will be affected. Error correction coding can then be used to correct for the few erroneous subcarriers. The word orthogonal indicates that there is a precise mathematical relationship between the frequencies of the carriers in the system. In a normal frequency-division multiplex system, many carriers are spaced apart in such a way that the signals can be received using conventional filters and demodulators. In such receivers, guard bands are introduced between the different carriers and in the frequency domain, which results in a lowering of spectrum efficiency. It is possible, however, to arrange the carriers in an OFDM signal so that the sidebands of the individual carriers overlap and the signals are still received without adjacent carrier interference. To do this, the carriers must be mathematically orthogonal. The word orthogonal indicates that there is a precise mathematical relationship between the frequencies of the carriers in the system. In a normal frequency-division multiplex system, many carriers are spaced apart in such a way that the signals can be received using conventional filters and demodulators. In such receivers, guard bands are introduced between the different carriers and in the frequency domain, which results in a lowering of spectrum efficiency. It is possible, however, to arrange the carriers in an OFDM signal so that the sidebands of the individual carriers overlap and the signals are still received without adjacent carrier interference. To do this, the carriers must be mathematically orthogonal.

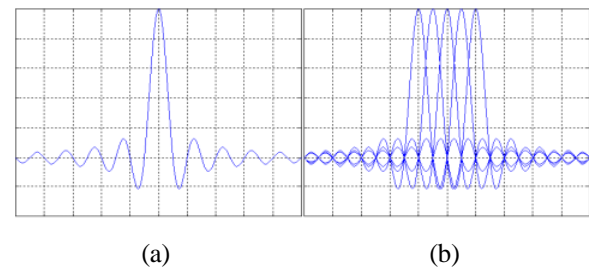

Figure 1: Spectra of (a) an OFDM sub-channel and (b) an OFDM signal.

S. B. Weinstein and P.M. Ebert made good contribution to OFDM; Discrete Fourier transform (DFT) method was proposed to perform the base band modulation and demodulation [4]. DFT is an efficient signal processing algorithm. It eliminates the banks of sub carrier oscillators. They used guard space between symbols to combat ICI and ISI problem. This system did not obtain perfect orthogonality between sub carriers over a dispersive channel. It was Peled and Ruiz who introduced cyclic prefix (CP) that solves the orthogonality issue [5]. They filled the guard space with a cyclic extension of the OFDM symbol. It is assumed the CP is longer than impulse response of the channel. Figure 1(a) and (b) show the spectrum of the individual signal of the sub-channel and the spectrum of the OFDM signal. Figure 1 shows that at the center frequency of each subcarrier, there is no crosstalk from other channels. Therefore, if we use DFT at the receiver and calculate correlation values with the center of frequency of each subcarrier, we recover the transmitted data with no crosstalk. In addition, using the DFT-based multicarrier technique, frequency-division multiplex is achieved not by band-pass filtering but by baseband processing. The OFDM transmission scheme has the following key advantages:

- Makes efficient use of the spectrum by allowing overlap.
- By dividing the channel into narrowband flat fading sub-channels, OFDM is more resistant to frequency selective fading than single carrier systems are.
- Eliminates Inter Symbol Interference (ISI) through use of a cyclic prefix.
- Using adequate channel coding and interleaving one can recover symbols lost due to the frequency selectivity of the channel.
- Channel equalization becomes simpler than by using adaptive equalization techniques with single carrier systems.
- It is possible to use maximum likelihood decoding with reasonable complexity, OFDM is computationally efficient by using FFT techniques to implement the modulation and demodulation functions.
- In conjunction with differential modulation there is no need to implement a channel estimator.

<http://www.cisjournal.org>

- Is less sensitive to sample timing offsets than single carrier systems are.
- Provides good protection against co-channel interference and impulsive parasitic noise.

In terms of drawbacks OFDM has the following characteristics:

- The OFDM signal has a noise like amplitude with a very large dynamic range, therefore it requires RF power amplifiers with a high peak to average power ratio.
- It is more sensitive to carrier frequency offset and drift than single carrier systems are due to leakage of the DFT.

To generate OFDM successfully the relationship between all the carriers must be carefully controlled to maintain the orthogonality of the carriers. For this reason, OFDM is generated by first choosing the spectrum required, based on the input data, and modulation scheme used. Each carrier to be produced is assigned some data to transmit. The required amplitude and phase of the carrier is then calculated based on the modulation scheme (typically differential BPSK, QPSK, or QAM). The required spectrum is then converted back to its time domain signal using an Inverse Fourier Transform. In most applications, an Inverse Fast Fourier Transform (IFFT) is used. The IFFT performs the transformation very efficiently, and provides a simple way of ensuring the carrier signals produced are orthogonal.

The Fast Fourier Transform (FFT) transforms a cyclic time domain signal into its equivalent frequency spectrum. This is done by finding the equivalent waveform, generated by a sum of orthogonal sinusoidal components. The amplitude and phase of the sinusoidal components represent the frequency spectrum of the time domain signal. The IFFT performs the reverse process, transforming a spectrum (amplitude and phase of each component) into a time domain signal. An IFFT converts a number of complex data points, into the time domain signal of the same number of points. Each data point in frequency spectrum used for an FFT or IFFT is called a bin. The orthogonal carriers required for the OFDM signal can be easily generated by setting the amplitude and phase of each frequency bin, then performing the IFFT. Since each bin of an IFFT corresponds to the amplitude and phase of a set of orthogonal sinusoids, the reverse process guarantees that the carriers generated are orthogonal. Figure 2 below shows the configuration for a basic OFDM transmitter and receiver. The signal generated is at base-band and so to generate an RF signal the signal must be filtered and mixed to the desired transmission frequency.

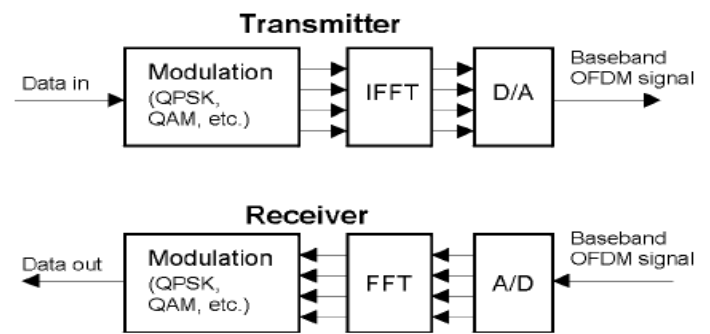

Figure 2: Basic FFT, OFDM transmitter and receiver

3. PROJECT METHODOLOGY AND SIMULATION RESULTS

An OFDM system was modeled using Matlab to allow various parameters of the system be varied and tested. The aim of this simulation is to measure the performance of OFDM under different channel conditions, and to allow for different OFDM configurations to be tested. Four main criteria were used to assess the performance of the OFDM system, which are its tolerance to multipath delay spread, peak power clipping, channel noise and time synchronization errors.

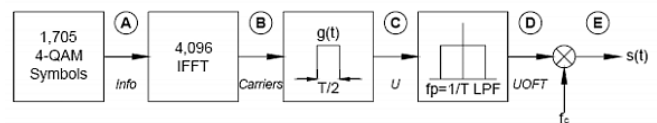

Figure 3: OFDM symbol generation simulation.

OFDM Transmission: $(4,096-1,705 = 2,391)$ zeros were added to the signal info at (A) to achieve over-sampling, $2X$, and to center the spectrum. Figure 4a shows the result of this operation. The first step to produce a continuous-time signal is to apply a transmit filter, $g(t)$, to the complex signal carriers and then apply a Butterworth filter of order 13 and cut-off frequency of approximately $1/T$ in order to avoid aliasing.

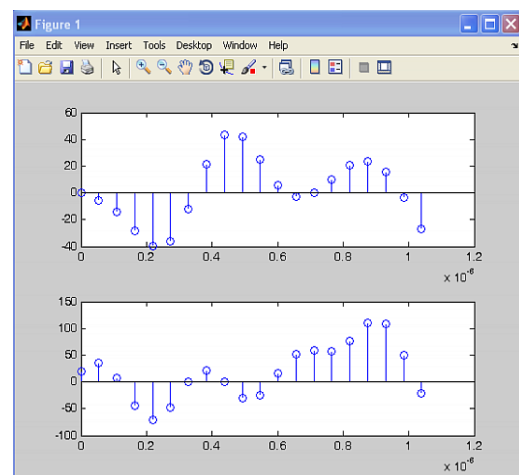

Figure 4a: Time response of signal carriers at (B).

http://www.cisjournal.org

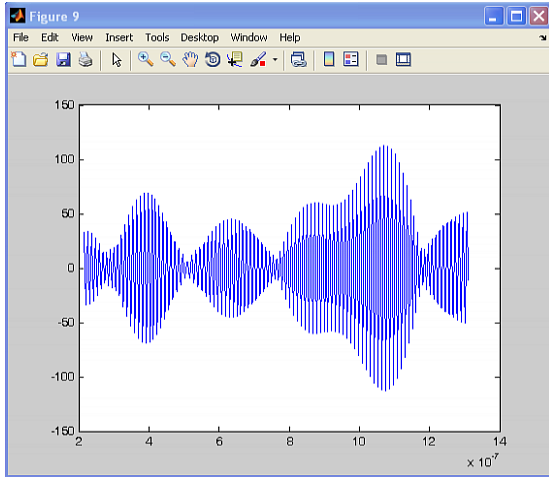

Figure 4b: Time response of signal s(t) at (E).

The next step is to perform the quadrature multiplex double-sideband amplitude modulation of uoft(t). In this modulation, an in-phase signal m_I(t) and a quadrature signal m_Q(t) are modulated using the formula [6].

$$s(t) = m_I(t) \cos(2\pi f_c t) + m_Q(t) \sin(2\pi f_c t) \tag{Eq 1}$$

where, s(t) can be expanded as follows:

$$s(t) = \sum_{k=K_{min}}^{K_{max}} \text{Re}(c_{0,0,k}) \cos \left[2\pi \left(\left(\frac{k - K_{max} + K_{min}}{T_u} \right) + f_c \right) t - \frac{\pi}{T_u} \right] - \sum_{k=K_{min}}^{K_{max}} \text{Im}(c_{0,0,k}) \sin \left[2\pi \left(\left(\frac{k - K_{max} + K_{min}}{T_u} \right) + f_c \right) t - \frac{\pi}{T_u} \right] \tag{Eq 2}$$

where, the in-phase and quadrature signals are the real and imaginary parts of C_{m,l,k}, the 4-QAM symbols, respectively.

The corresponding operation for the IFFT process is

$$s(t) = uoft_I(t) \cos(2\pi f_c t) - uoft_Q(t) \sin(2\pi f_c t). \tag{Eq 3}$$

The time responses for the complete signal, s(t), is shown in Figure 4b above.

where:

- k denotes the carrier number;
- l denotes the OFDM symbol number;
- m denotes the transmission frame number;
- T_u is the inverse of the carrier spacing;
- is the duration of the guard interval;

f_c is the central frequency of the radio frequency (RF) signal;

c_{m,0,k} complex symbol for carrier k of the Data symbol no.1 in frame number m;

c_{m,1,k} complex symbol for carrier k of the Data symbol no.2 in frame number m.

4. OFDM RECEPTION

The design of an OFDM receiver is open; i.e., there are only transmission standards. With an open receiver design, most of the research and innovations are done in the receiver. For example, the frequency sensitivity drawback is mainly a transmission channel prediction issue, something that is done at the receiver; therefore, only a basic receiver structure is presented in this report. A basic receiver that just follows the inverse of the transmission process is shown in Figure 5.

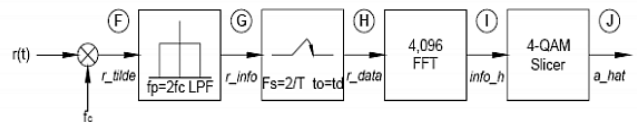

Figure 5: OFDM reception simulation.

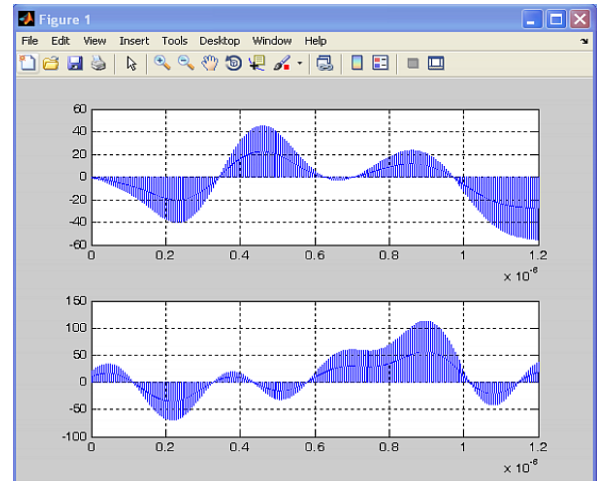

Figure 6a: Time response of signal r_tilde at (F).

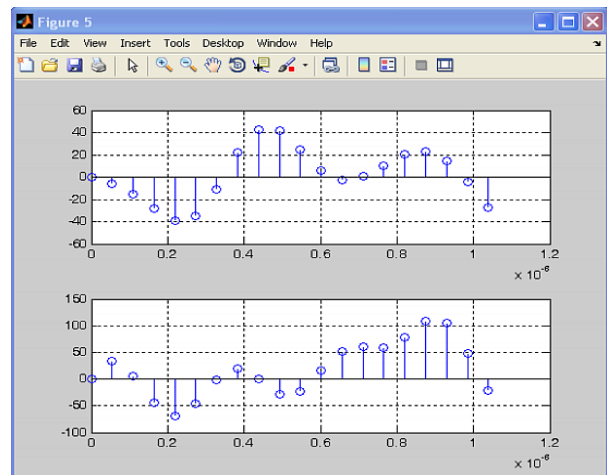

Figure 6b: Time response of signal r_data at (H).

OFDM is very sensitive to timing and frequency offsets. The delay produced by the filtering operation has

<http://www.cisjournal.org>

to be considered. For this simulation, the delay produced by the reconstruction and demodulation filters is about $t_d=64/R_s$ and it is the cause of the slight differences we can see between the transmitted and received signals (Figure 4b vs Figure 6a). With the delay taken care of the result of this simulation is shown in Figure 6a and Figure 6b.

4.1. Results and Discussion

The performance of the OFDM signals shows its suitability for transmission in a broadband wireless communication and its high tolerance to interference. E Lawrey (1997) verified the performance of the OFDM in relation to four main parameters: Multipath Delay, peak power clipping, Gaussian noise tolerance and timing requirement [7].

4.2. Multipath Delay Spread Immunity

Figure 7 shows that the BER is very low for a delay spread of less than approximately 256 samples. In a practical system (i.e. one with a 1.25 MHz bandwidth) this delay spread would correspond to ~80 msec. This delay spread would be for a reflection with 24 km extra path length. The results showed extreme multipath conditions.

BER against Multipath Delay Spread.

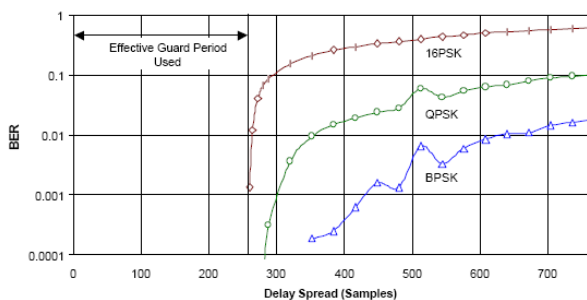

Figure 7: Delay Spread tolerance of OFDM

The guard period used consisted of 256 samples of zero amplitude, and 256 samples of a cyclic extension of the symbol. The results showed that the tolerable delay spread matched the time of the cyclic extension of the guard period. It was verified that the tolerance is due to the cyclic extension not the zeroed period with other simulations.

For a delay spread that is longer than the effective guard period, the BER rises rapidly due to the inter-symbol interference. The maximum BER that will occur is when the delay spread is very long (greater than the symbol time) as this will result in strong inter-symbol interference. In a practical system the length of the guard period can be chosen depending on the required multipath delay spread immunity required.

4.3. Peak Power Clipping

The transmitted OFDM signal could be heavily clipped with little effect on the received BER. In fact, the signal could be clipped by up to 9 dB without a significant increase in the BER. This means that the signal is highly resistant to clipping distortions caused by the power amplifier used in transmitting the signal. It also

means that the signal can be purposely clipped by up to 6 dB so that the peak to RMS ratio can be reduced allowing an increased transmitted power. Figure 8 shows the effect of peak power clipping for the OFDM signals.

BER against Peak Power Clipping for OFDM

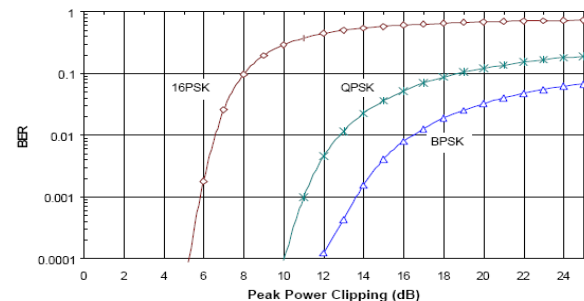

Figure 8: Effect of peak power clipping for OFDM.

4.4. Gaussian Noise Tolerance of OFDM

The SNR performance of OFDM is similar to a standard single carrier digital transmission. This is to be expected, as the transmitted signal is similar to a standard Frequency Division Multiplexing (FDM) system. Figure 9 shows that using QPSK the transmission can tolerate a SNR of >10-12 dB. The bit error rate BER gets rapidly worse as the SNR drops below 6 dB. However, using BPSK allows the BER to be improved in a noisy channel, at the expense of transmission data capacity. Using BPSK the OFDM transmission can tolerate a SNR of >6-8 dB. In a low noise link, using 16PSK can increase the capacity. If the SNR is >25 dB 16PSK can be used, doubling the data capacity compared with QPSK.

BER against Channel Signal to Noise Ratio for OFDM

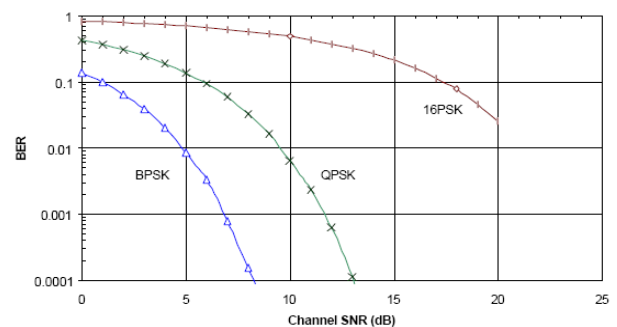

Figure 9: BER against SNR for OFDM using BPSK, QPSK and 16PSK

4.5. Timing Requirements

When an OFDM receiver is initially switched on it will not be synchronized with the transmitted signal. So a synchronization method was required. The proposed method was that the OFDM signal could be broken up into frames, where each frame transmits a number of symbols (between 10 - 1000). At the start of each frame a null symbol is transmitted, thus allowing the start of the frame to be detected using envelope detection. However using

envelope detection only allows the start to be detected to within a couple of sample, depending on the noise in the system. It was not known whether this timing accuracy was sufficient. Figure 10 shows the effect of start time error on the received BER. This implied that the starting time can have an error of up to 256 samples before there is any effect on the BER. This length matches the cyclic extension period of the guard interval which is due to the guard period maintaining the orthogonality of the signal.

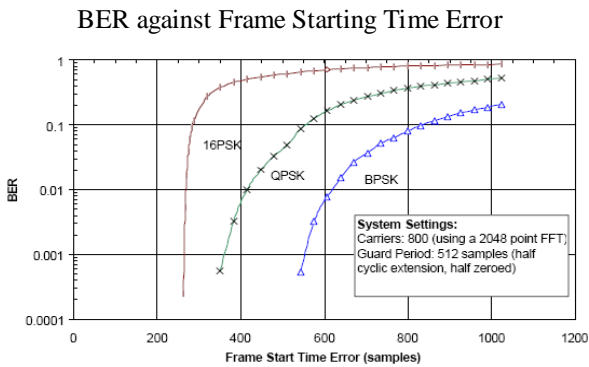

Figure 10: Effect of frame synchronization error on the received OFDM signal.

5. CONCLUSION

This work provides a model and simulation for the OFDM transmission in a broadband wireless communication environment. OFDM is a suitable technique as a modulation technique for high performance wireless telecommunications. It provides many advantages as a choice for transmission in such communication system [8]. Now, OFDM has been adopted as digital audio broadcasting (DAB) standard and for terrestrial digital video broadcasting (DVB). In fixed-wire applications, OFDM is employed in asynchronous digital subscriber line (ADSL) and high bit-rate digital subscriber line (HDSL) systems. It has been proposed for power line communications systems as well due to its resilience to dispersive channel and narrow band interference. However the frequency selectivity characteristics for OFDM are area that still needs to be further researched on. OFDM was found to perform very well compared with CDMA; it performs better than CDMA in many areas for a single and multicell environment. OFDM was found to allow up to 2-10 times more users than CDMA in a single cell environment and from 0.7 – 4 times more users in a multi-cellular environment. The difference in user capacity between OFDM and CDMA was dependent on whether cell sectorization and voice activity detection is used. It was found that CDMA only performs well in a multi-cellular environment where a single frequency is used in all cells. This increases the comparative performance against other systems that require a cellular pattern of frequencies to reduce inter-cellular interference. One important major area, which hasn't been investigated, is the problems that may be encountered when OFDM is used in a multiuser environment.

REFERENCES

- [1] Dusan Matiae, "OFDM as a possible modulation technique for multimedia applications in the range of mm waves," TUD-TVS, 30-10-1998.
- [2] R. W. Chang, "Synthesis of Band limited Orthogonal Signals for Multichannel Data Transmission," Bell System Tech. J., pp. 1775-1796, Dec, 1966.
- [3] B. R. Saltzberg, "Performance of an Efficient Parallel Data Transmission Sytem," IEEE Trans. Comm. , pp 805-811, Dec, 1967.
- [4] S. B. Weinstein and P.M. Ebert, "Data transmission by frequency division multiplexing using the discrete fourier transform," IEEE Transactions on Communication Technology", vol. COM-19, pp. 628-634, October 1971.
- [5] A. Peled and A. Ruiz, "Frequency Domain Data Transmission using Reduced Computational Complexity Algorithms," In Proc. IEEE Int. Conf. Acoust., Speech, Signal Processing, pp 964-967, Denver, CO, 1980.
- [6] R. V. Nee and R. Prasad, OFDM Wireless Multimedia Communications, Norwood, MA: Artech House, 2000.
- [7] E. Lawrey, "The suitability of OFDM as a modulation technique for wireless telecommunications, with a CDMA comparison." James Cook University, 1997.
- [8] White paper, "Orthogonal Frequency Division Multiplexing (OFDM) Explained", Magis Networks, Inc. 2001.
- [9] L. Hanzo, M. Munster, B.J. Choi and T. Keller, "OFDM and MC-CDMA for Broadband Multi-User Communications, WLANs and Broadcasting," IEEE Press, Wiley.
- [10] Erich Cosby, "Orthogonal Frequency Division Multiplexing (OFDM): Tutorial and Analysis", 11-12-2001, Virginia Tech. Northern Virginia Center.
- [11] D. Magill, "Spread-Spectrum Technology for Commercial Applications", Proceedings of the IEEE, Vol. 82, No. 4, April 1994.
- [12] T. S. Rappaport, "Wireless Communications Principles & Practice", IEEE Press, New York, Prentice Hall, pp. 169-177, 1996.
- [13] D. Jiraud, "Broadband CDMA for Wireless Communications", Applied Microwave & Wireless, 1995.
- [14] Mosier, R. R., and Clabaugh, R.G., A Bandwidth Efficient Binary Transmission System, IEEE Trans., Vol. 76, pp. 723 - 728, Jan. 1958.